



功得電子工業股份有限公司
CONQUER ELECTRONICS CO.,LTD.

規格書

Spec. No. SFA425

Specification For Approval

型號 : CQ-206D (PF) 保險絲筒座

Model : CQ-206D (PF) Fuse Holder

www.conquer.com.tw

五股廠：新北市五股區五權五路26號(新北產業園區)
Wugu Factory: No.26, Wucyuan 5th Rd., Wugu Dist.,
(New Taipei Industrial Park) New Taipei City
24888, Taiwan
TEL: +886-2-89902189(Rep.)
FAX: +886-2-8990-2577

北投廠：台北市北投區立德路120巷15號
Peitou Factory: No. 15, Lite Road, Peitou,
Taipei 11259, Taiwan.
TEL: +886-2-2895-8895(代表號)
FAX: +886-2-2895-8880



History of Change

REV.	Description	Date	Drawn	Designed	Checked	Approved
1	1.Issue	2015.11.20	林嘉豪	邱俊傑	蔡進義 趙宏遠	蔡其湖
2	1.印字新增I為生產地標記。 2.新增保險絲蓋材質。	2017.09.14	林嘉豪	黃琦志	蔡進義 趙宏遠	蕭煥益
3	1. 新增第6項標記/安規認證	2018.08.07	林嘉豪	黃琦志	蔡進義 趙宏遠	蕭煥益

Conquer Electronics Co., LTD.

No.26, Wucyuan 5th Rd., Wugu Dist.,(New Taipei Industrial Park) New Taipei City 24888, Taiwan TEL:+886-2-8990-2189 (代表號) FAX:+886-2-8990-2577

Peitou Factory : No. 15, Lane 120, Lite Road, Peitou, 11259, Taipei, Taiwan. TEL: +886-2-2895-8895 (代表號) FAX:+886-2-2895-8880

E-mail: conqfuse@ms62.hinet.net Official Website: <http://www.conquer.com.tw>

1. 適用範圍 Available Range : For 5x20 mm fuse holder.

2. 形狀及尺寸如下圖 Shape & Size as following illustrations 。 Unit : mm Tolerance : ± 0.2

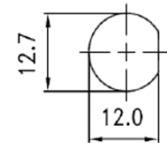
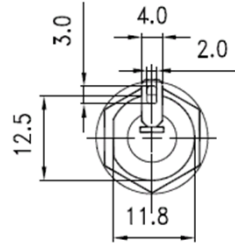
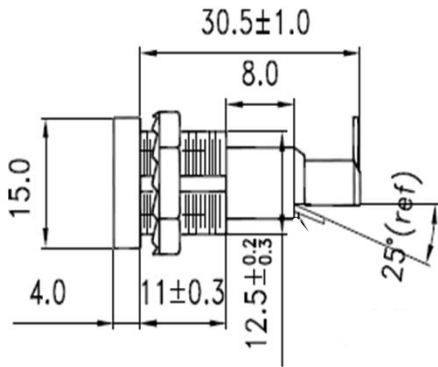

安裝孔 Mounting Hole

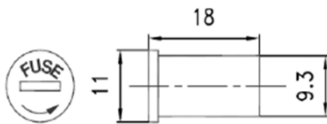

蓋子 Cover

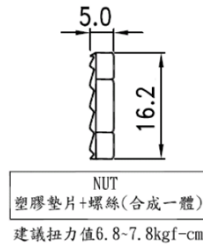

NUT
塑膠墊片+螺絲(合成一體)
建議扭力值6.8-7.8kgf-cm

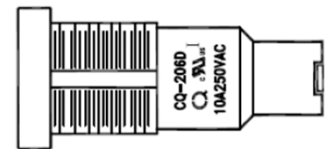
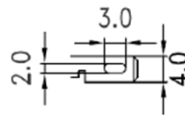

本體印字 Body Marking

3. 材料 Material :

- 3.1 本體 Body : 電木粉 Phenolic Molding Compound.
- 3.2 蓋子 Cover : 聚對苯二甲酸丁二酯 Polybutylene terephthalate.
- 3.3 銅合金鍍鎳或錫 Nickel or tin plated copper alloy.

4. 電性特性 Electrical Characteristics :

- 4.1 額定電流 Rated Current : 10A 250V 。
- 4.2 絕緣阻抗 Insulation Resistance : Min 100MΩ(at 500V DC) 。
- 4.3 接觸阻抗 Contact Resistance : 5mΩ (at 1A DC) 。
- 4.4 介電強度 Dielectric Strength : AC 1500V Min (60 sec) 。
- 4.5 絕緣體 : 阻燃UL 94 V0熱塑性材料。
Insulating Body : Flame retarding UL 94 V0 Thermoplastic Material.

5. 類型 Type : 卡口式旋鈕 Bayonet Knob 。

6. 標記/安規認證 Mark/ Safety Certification : 

Conquer Electronics Co., LTD.

No.26, Wucyuan 5th Rd., Wugu Dist.,(New Taipei Industrial Park) New Taipei City 24888, Taiwan TEL:+886-2-8990-2189 (代表號) FAX:+886-2-8990-2577

Peitou Factory : No. 15, Lane 120, Lite Road, Peitou, 11259, Taipei, Taiwan. TEL: +886-2-2895-8895 (代表號) FAX:+886-2-2895-8880

E-mail: conqfuse@ms62.hinet.net Official Website: <http://www.conquer.com.tw>



7. 儲存方式及期限 Storage Methods And Duration :

7.1 儲存條件：建議儲存溫度 25°C ($+5^{\circ}\text{C}$, -10°C)、溼度 $40\%RH$ ($+20\%RH$, $-20\%RH$)。

Storage conditions : The recommended storage temperature 25°C ($+5^{\circ}\text{C}$, -10°C)、relative humidity $40\%RH$ ($+20\%RH$, $-20\%RH$).

7.2 保存期限 Expiration date : 1 year。

8. 包裝方式 Packing :

CQ-206D (PF) : 2000 pcs/box.

CQ-206D (PF)-0 (Cover+Body+NUT) : 100 pcs/bag.

Conquer Electronics Co., LTD.

No.26, Wucyuan 5th Rd., Wugu Dist.,(New Taipei Industrial Park) New Taipei City 24888, Taiwan TEL:+886-2-8990-2189 (代表號) FAX:+886-2-8990-2577

Peitou Factory : No. 15, Lane 120, Lite Road, Peitou, 11259, Taipei, Taiwan. TEL: +886-2-2895-8895 (代表號) FAX:+886-2-2895-8880

E-mail: conqfuse@ms62.hinet.net Official Website: <http://www.conquer.com.tw>