

CQ-115

For AST
Mini Blade Type Fuse

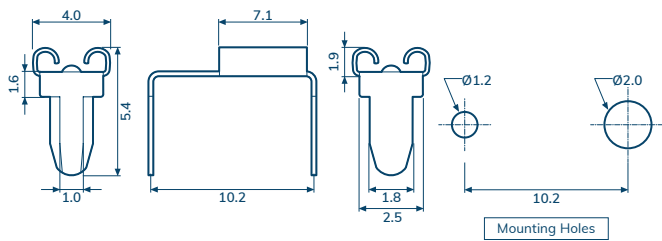
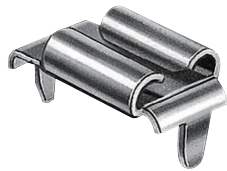

CQ-216(G)

For 10.3mm Dia. Fuses

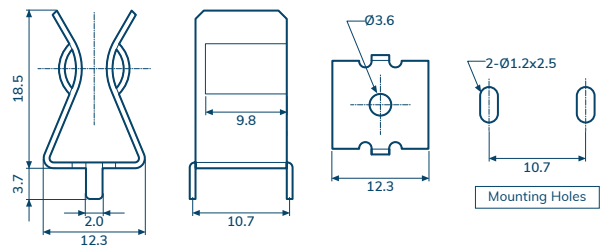
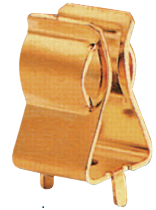

CQ-05CT

Tape / Reel
For 5mm Dia. Fuse

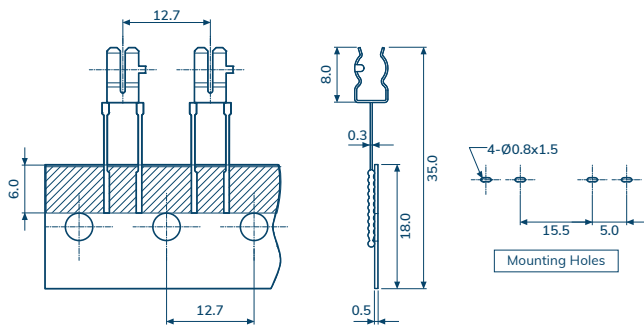

CQ-216

For 10.3mm Dia. Fuses

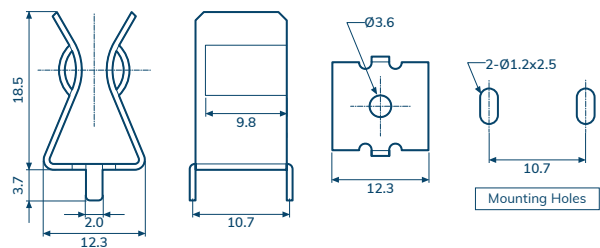
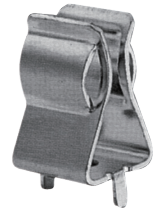

Item Number	CQ-115	CQ-216(G)	CQ-05CT	CQ-216
Metal Material	Brass	Brass	Phosphor Bronze	Brass
Material Thickness	0.3 mm	0.7 mm	0.3 mm	0.7 mm
Suitable Rated Current	15 A	30 A	10 A	30 A
Fuse Type	AST Type	Ear Type	Ear Type	Ear Type
Plating Type	Bright Tin Plated	24Kt. Gold Plated	Bright Tin Plated	Bright Tin Plated